

14" x 48" ÉTAGÈRE MURALE EN ACIER INOXYDABLE TWSS-1448-SS

CARACTÉRISTIQUES

NSF

- ✓ Dimensions: 14" x 48"
- ✓ Charge maximale: 99 lbs
- ✓ Fait d'acier inoxydable de calibre 18, grade 430
- ✓ Supports de montage robustes
- ✓ Design mural peu encombrant

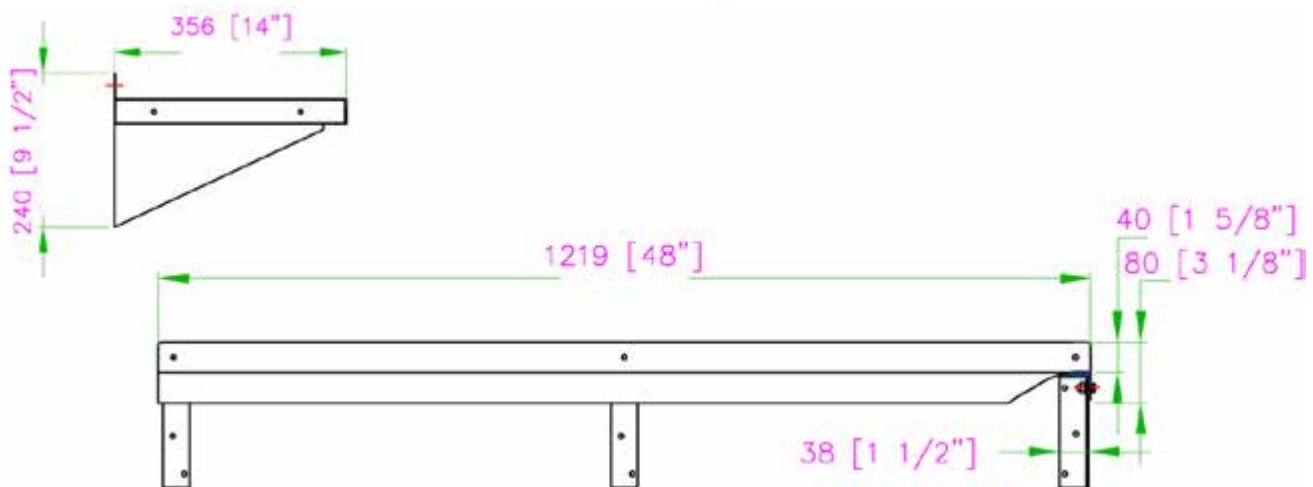

ASSEMBLAGE/SUPPORT



 Nous sommes sur les réseaux sociaux 

1.800.567.3620 | WWW.THORINOX.COM

PLUS DE PRODUITS

