

12" x 30" ÉTAGÈRE MURALE EN ACIER INOXYDABLE TWSS-1230-SS

CARACTÉRISTIQUES

NSF

- ✓ Dimensions: 12" x 30"
- ✓ Charge maximale: 55 lbs
- ✓ Fait d'acier inoxydable de calibre 18, grade 430
- ✓ Supports de montage robustes
- ✓ Design mural peu encombrant

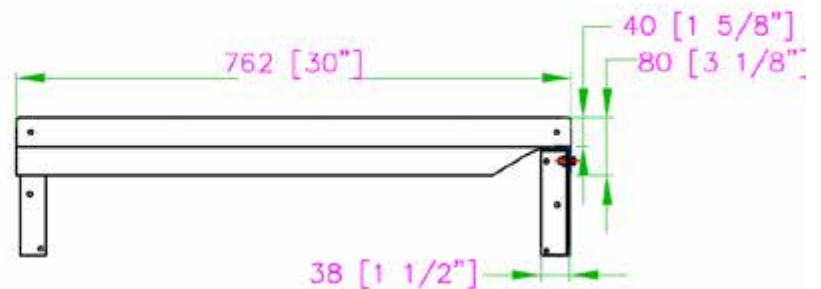
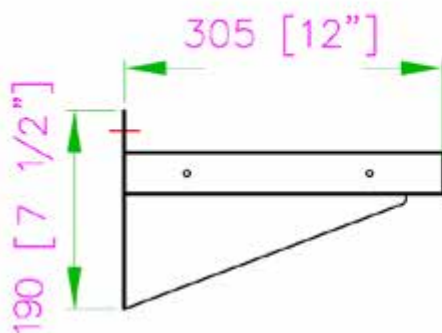
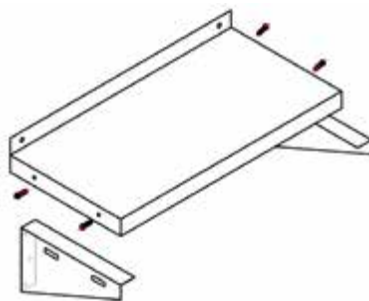

ASSEMBLAGE/SUPPORT



 Nous sommes sur les réseaux sociaux 

1.800.567.3620 | WWW.THORINOX.COM

PLUS DE PRODUITS

