

30" x 18" STAINLESS EQUIPMENT STAND DSTAND-3018-SS

FEATURES

- ✓ Entirely made of high quality 18 gauge 430 stainless steel
- ✓ Dimensions: 30" x 18" x 22"
- ✓ Stronger and non-welded corners
- ✓ Stainless undershelf & legs
- ✓ Easy to assemble



COMPLEMENTARY ACCESSORIES

- ✓ Set of swivel casters, 2 regular & 2 with brakes



YOU MIGHT ALSO LIKE...

- ✓ Stainless Steel Cabinet
- ✓ Stainless Steel Shelf

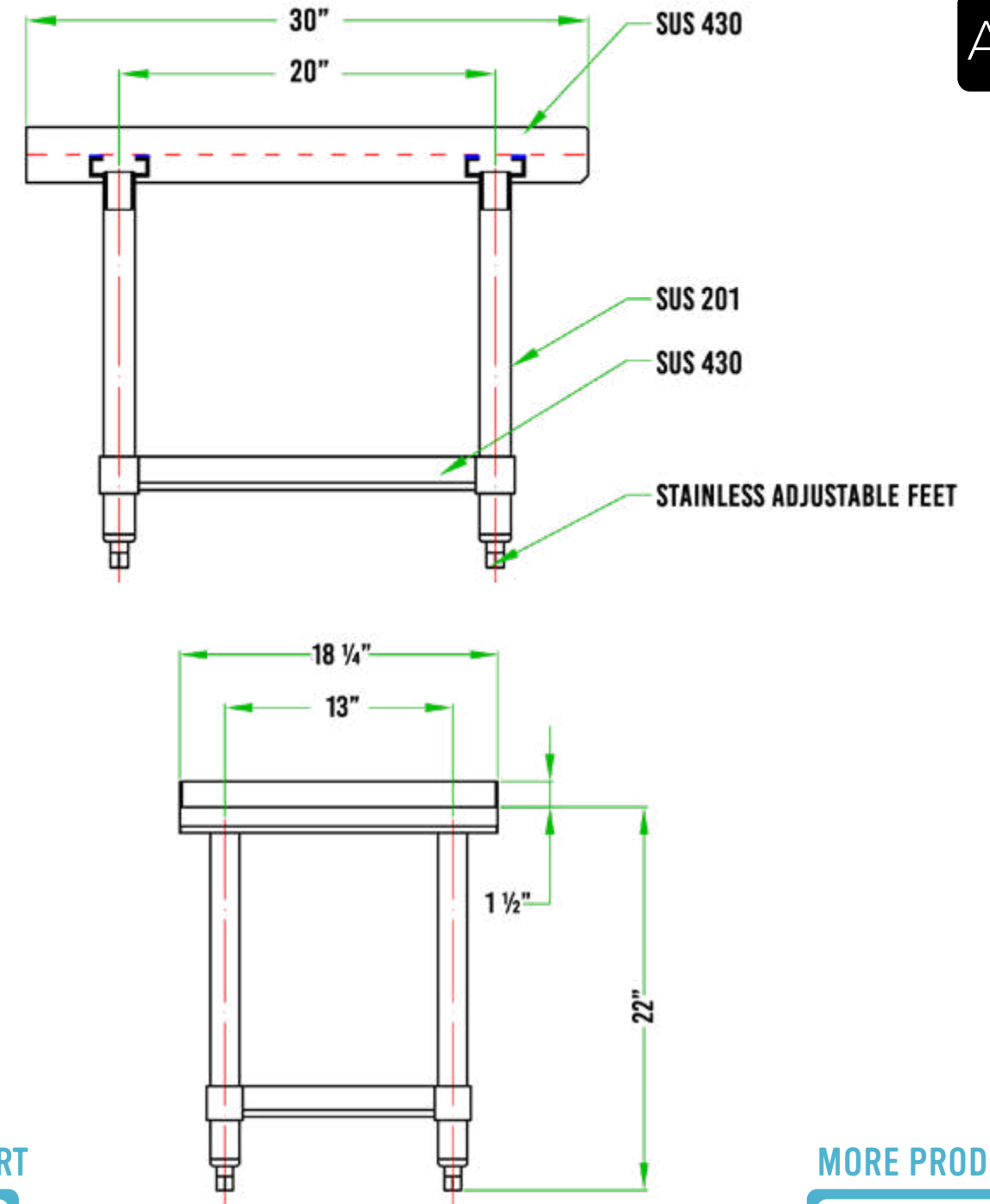
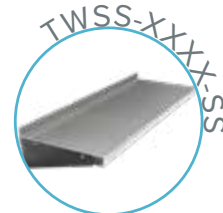
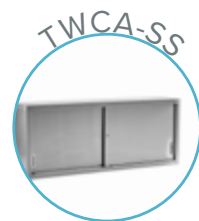

ASSEMBLY/SUPPORT



We're on social media!

MORE PRODUCTS

