

30" x 96" STAINLESS WORK TABLE

DSST-3096-SS

FEATURES

- ✓ Made with high quality 18 gauge 430 stainless steel
- ✓ Dimensions: 30" x 96" x 34"
- ✓ Comes with matching undershelf
- ✓ Knock down design: easy to assemble
- ✓ Load capacity:
Top: 330lbs Bottom: 110lbs



OPTIONAL ACCESSORIES

- ✓ Brace bar kit
- ✓ Extra stainless steel undershelf
- ✓ Single or double stainless steel drawer
- ✓ Set of swivel casters, 2 regular & 2 with brakes
- ✓ Adjustable stainless steel leg insert (max 2" for a total height of 36")
- ✓ Double pass-through overshelf



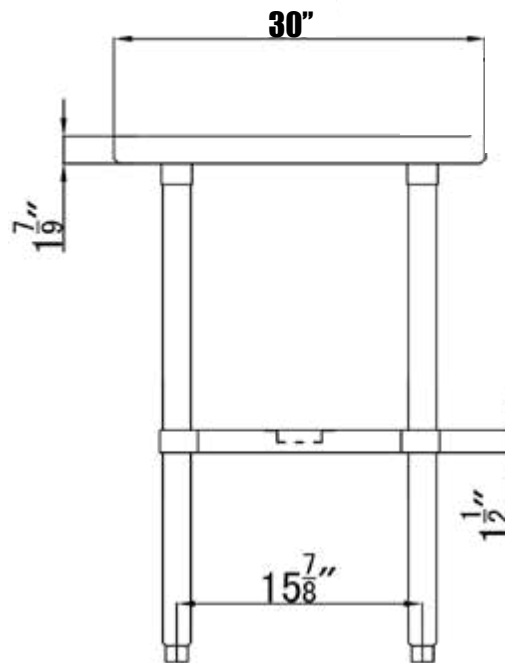
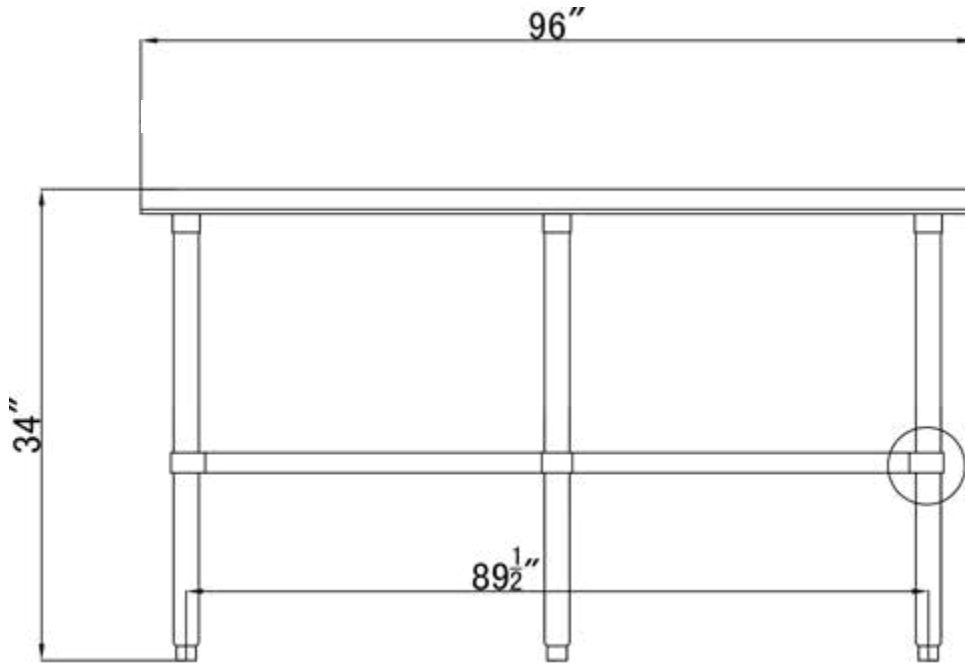

ASSEMBLY/SUPPORT



MORE PRODUCTS



We're on social media!