

30" x 84" INOXIDABLE TABLE DE TRAVAIL

DSST-3084-GS

2022RV.1

CARACTÉRISTIQUES

- ✓ Faite avec de l'acier inoxydable de calibre 18, grade 430
- ✓ Dimensions : 30" x 84" x 34"
- ✓ Étagère inférieure de 21^{3/4}" x 77^{1/2}" x 1^{5/8}" inclus
- ✓ Capacité de chargement: haut: 330lbs bas: 110lbs
- ✓ Design démontable: facile à assembler
- ✓ Dimensions du colis 86" x 32" x 4"



ACCESSOIRES OPTIONNELS

- ✓ Kit barres de renforcement
- ✓ Tablette en acier inoxydable
- ✓ Tiroir en acier inoxydable simple ou double
- ✓ Ensemble de roulettes pivotantes, 2 régulières + 2 avec frein
- ✓ Pattes réglable en acier inoxydable (max 2" pour une hauteur totale de 36")
- ✓ Tablette double

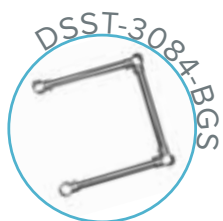

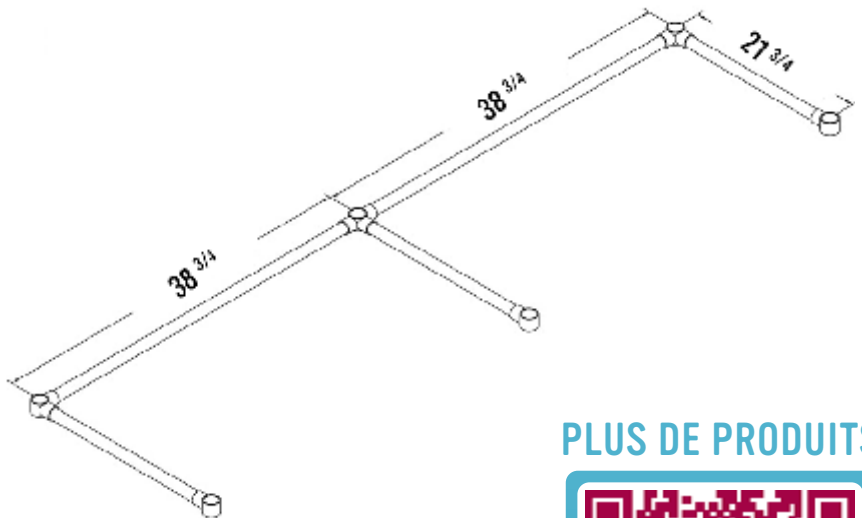
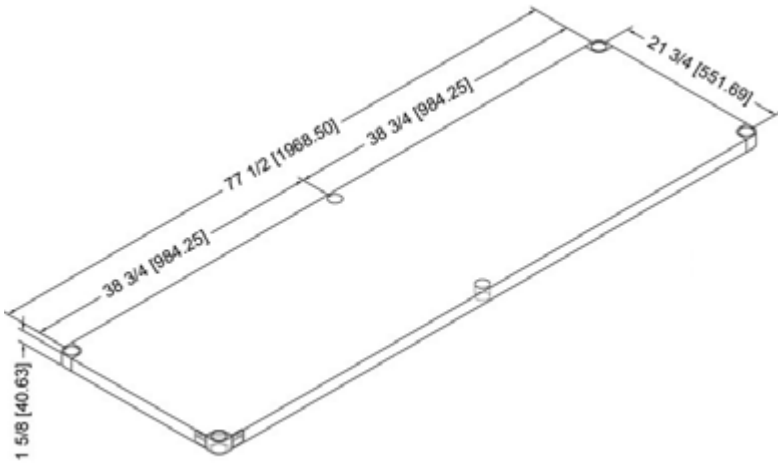
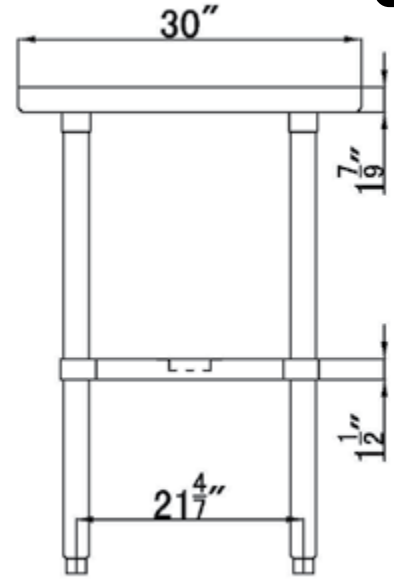
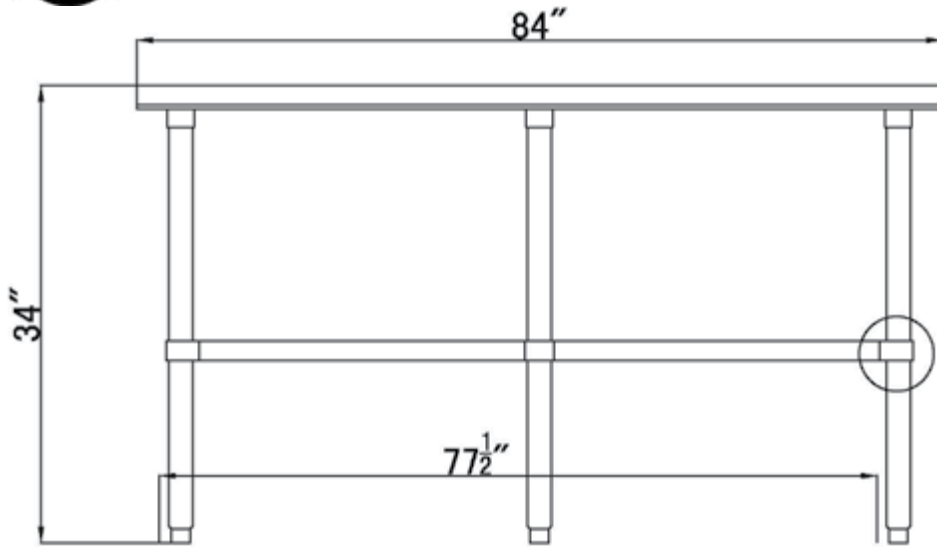

ASSEMBLAGE/SUPPORT



Nous sommes sur les réseaux sociaux

1.800.567.3620 | WWW.THORINOX.COM

PLUS DE PRODUITS

