

30" x 72" STAINLESS WORK TABLE

DSST-3072-GS

2022RV.1

FEATURES

- ✓ Made with high quality 18 gauge 430 stainless steel
- ✓ Dimensions: 30" x 72" x 34"
- ✓ Comes with 21^{3/4}" x 65^{1/2}" x 1^{5/8}" undershelf
- ✓ Load capacity:
Top: 330lbs Bottom: 110lbs
- ✓ Knock down design: easy to assemble
- ✓ Package Dimensions 74" x 32" x 4"



OPTIONAL ACCESSORIES

- ✓ Brace bar kit
- ✓ Extra stainless steel undershelf
- ✓ Single or double stainless steel drawer
- ✓ Set of swivel casters, 2 regular & 2 with brakes
- ✓ Adjustable stainless steel leg insert (max 2" for a total height of 36")
- ✓ Double pass-through overshelf

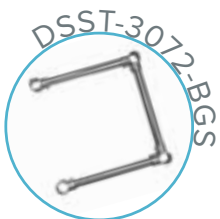

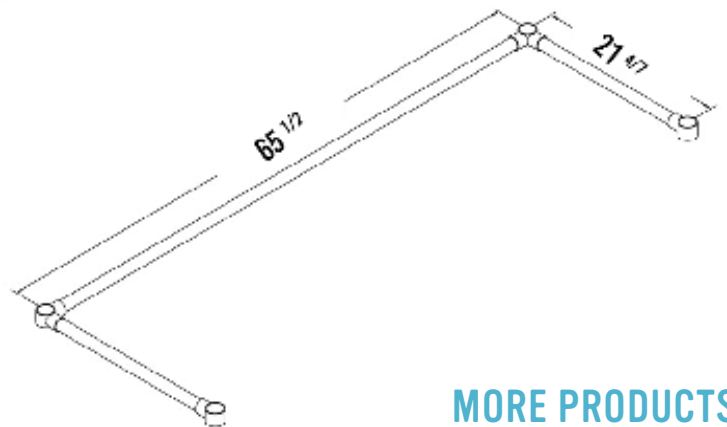
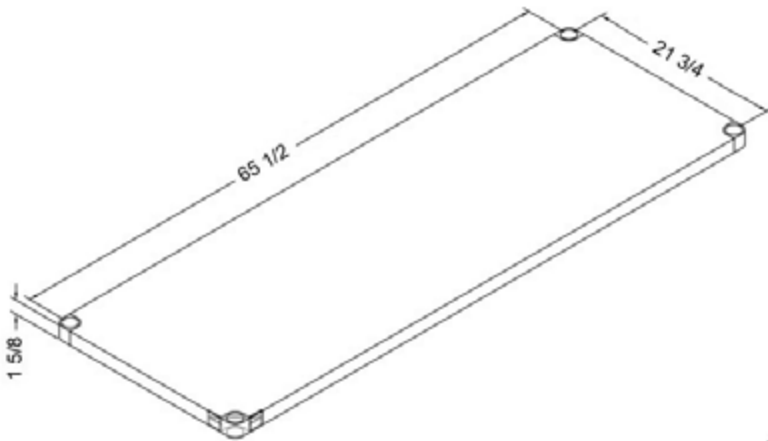
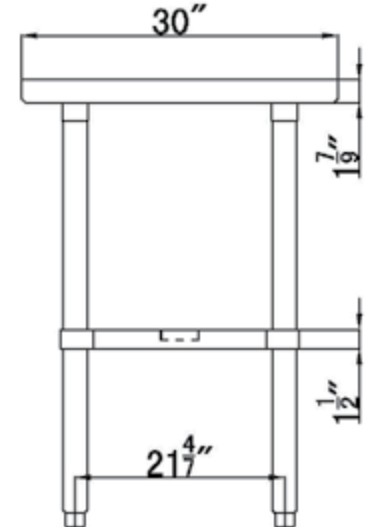
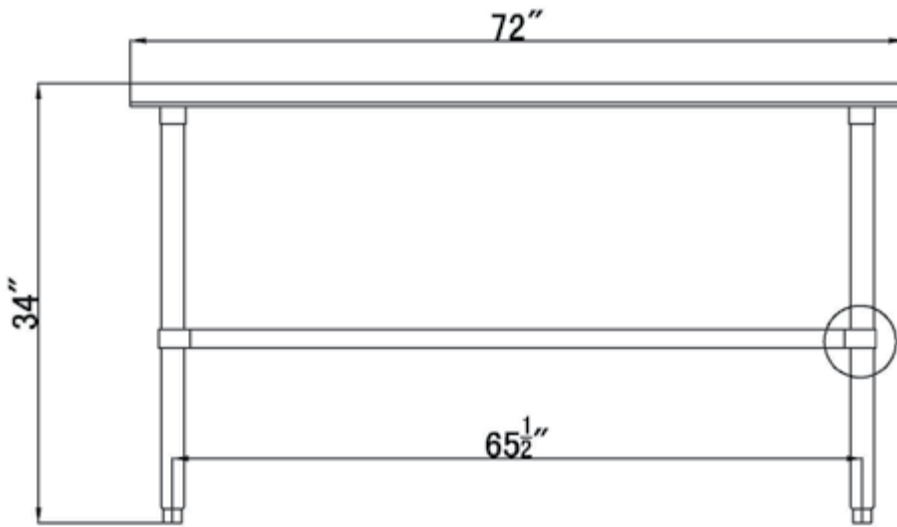

ASSEMBLY/SUPPORT



We're on social media!

MORE PRODUCTS

