

# 30" x 60" STAINLESS WORK TABLE

## DSST-3060-GS

2022RV.1

### FEATURES

- ✓ Made with high quality 18 gauge 430 stainless steel
- ✓ Dimensions: 30" x 60" x 34"
- ✓ Comes with 21<sup>3/4</sup>" x 53<sup>1/2</sup>" x 1<sup>5/8</sup>" undershelf
- ✓ Load capacity:  
Top: 330lbs Bottom: 110lbs
- ✓ Knock down design: easy to assemble
- ✓ Package Dimensions 62" x 32" x 4"



### OPTIONAL ACCESSORIES

- ✓ Brace bar kit
- ✓ Extra stainless steel undershelf
- ✓ Single or double stainless steel drawer
- ✓ Set of swivel casters, 2 regular & 2 with brakes
- ✓ Adjustable stainless steel leg insert (max 2" for a total height of 36")
- ✓ Double pass-through overshelf

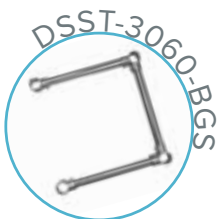

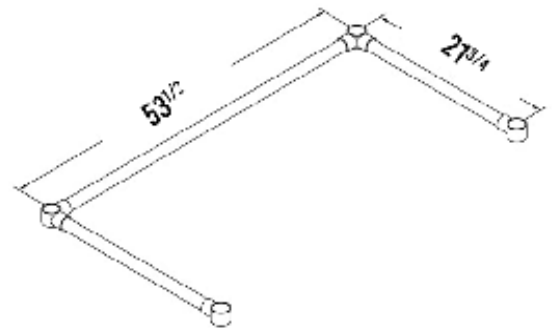
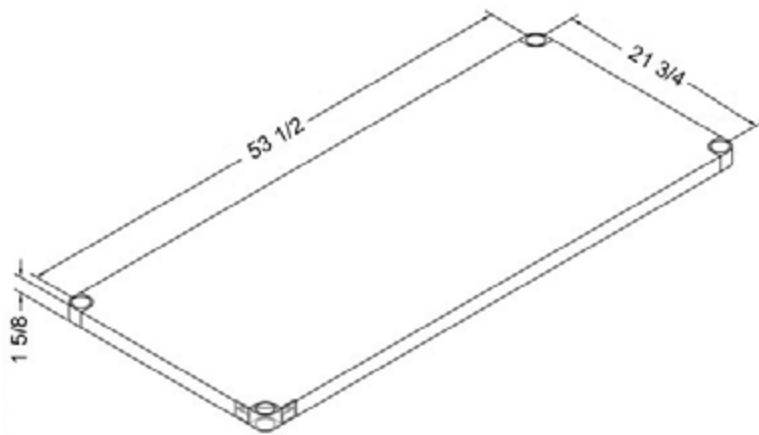
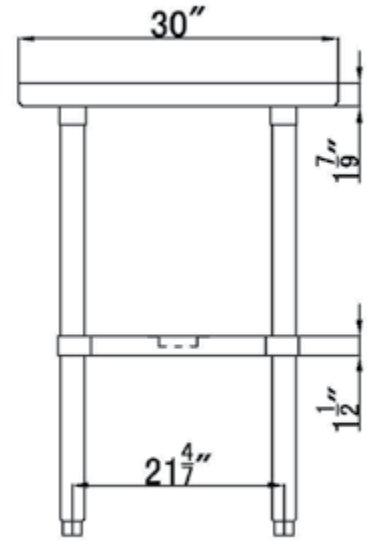
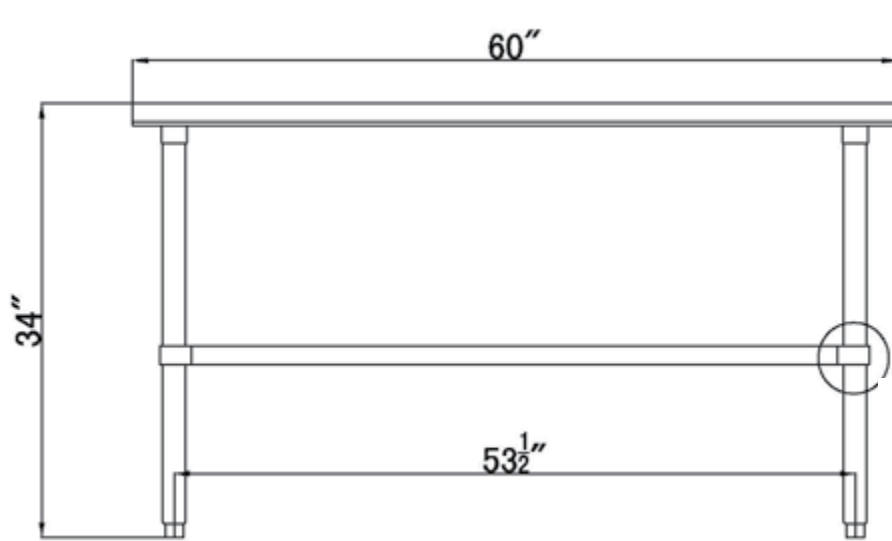

**ASSEMBLY/SUPPORT**



We're on social media!

**MORE PRODUCTS**

