

24" x 84" STAINLESS WORK TABLE

DSST-2484-BK

2022RV.1

FEATURES

- ✓ Made with high quality 18 gauge 430 stainless steel
- ✓ Dimensions: 24" x 84" x 34" with 5" backsplash
- ✓ Comes with 15^{7/8}" x 72^{1/2}" x 1^{5/8}" undershelf
- ✓ Load capacity:
Top: 330lbs Bottom: 110lbs
- ✓ Knock down design: easy to assemble
- ✓ Package Dimensions 86" x 28" x 9"



OPTIONAL ACCESSORIES

- ✓ Brace bar kit
- ✓ Extra stainless steel undershelf
- ✓ Simple or double stainless steel drawer
- ✓ Set of swivel casters, 2 regular + 2 with brakes
- ✓ Adjustable stainless steel leg insert (max 2" for a total height of 36")
- ✓ Double pass-through overshelf

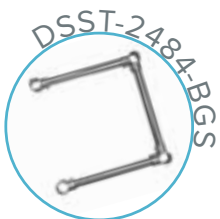

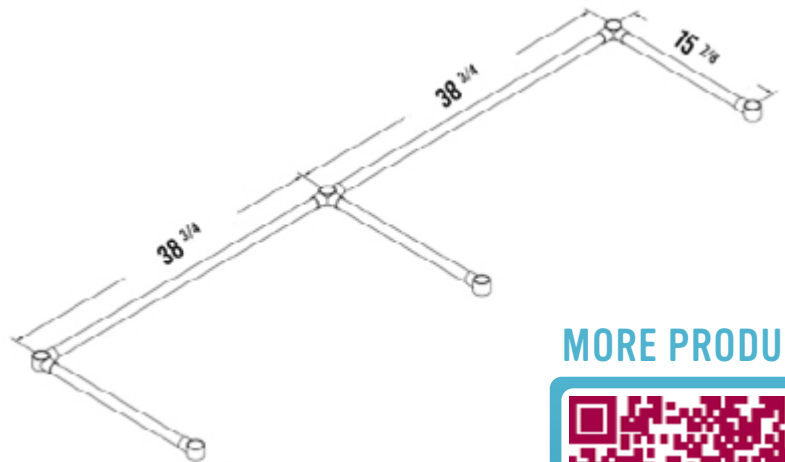
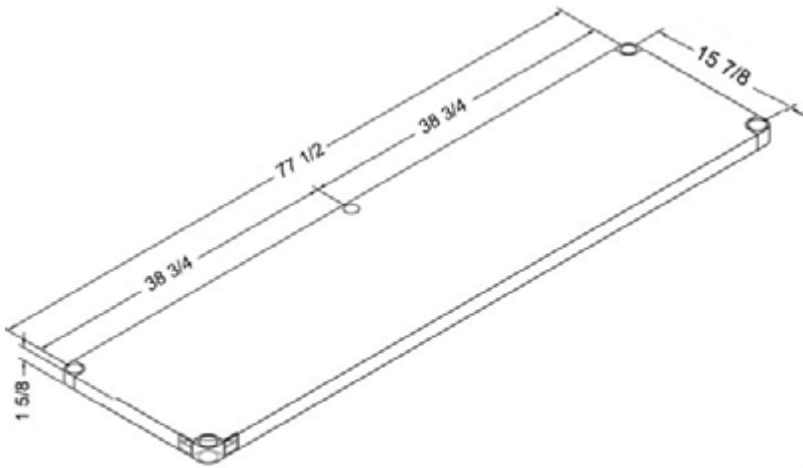
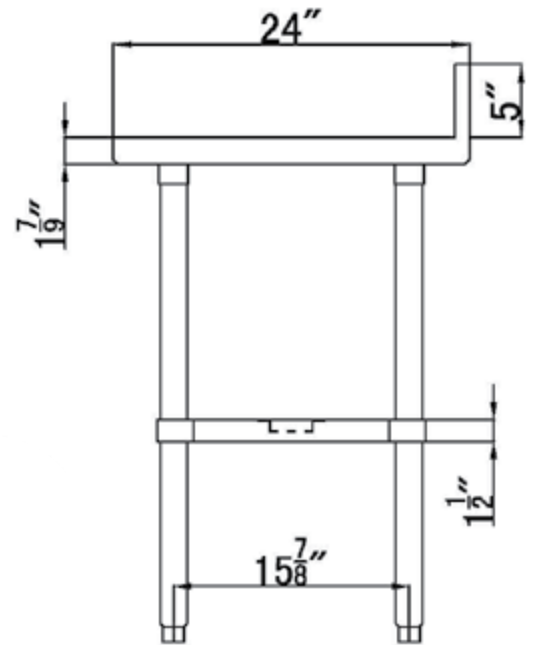
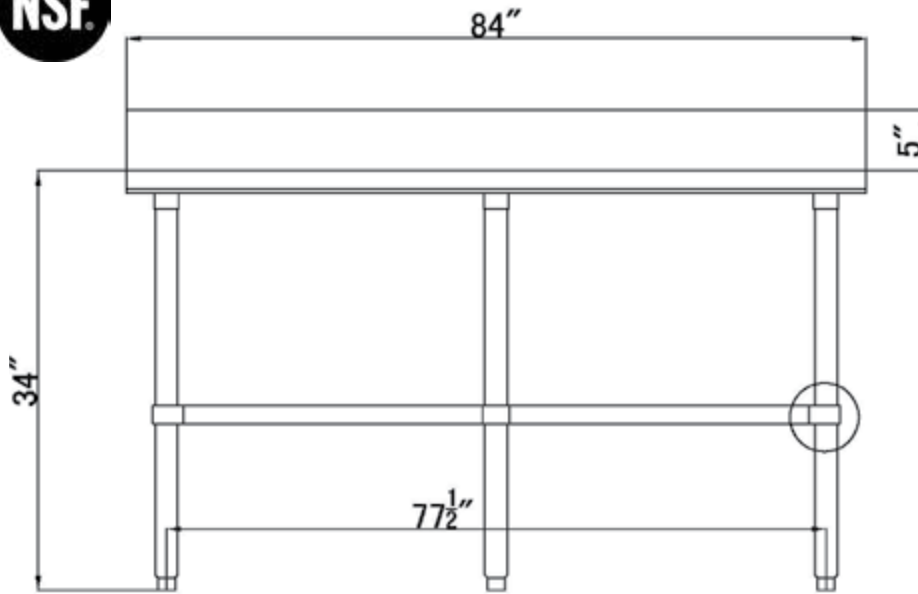

ASSEMBLY/SUPPORT



f We're on social media! **ig**

MORE PRODUCTS

