



DUS-3072-SS STAINLESS STEEL UNDERSHELF



Characteristics

- 18 gauge
- Stronger and non-welded corners

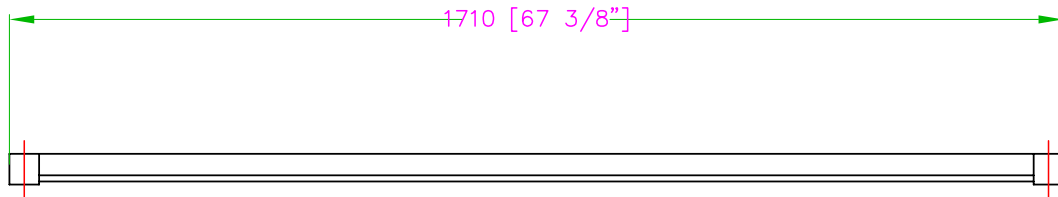
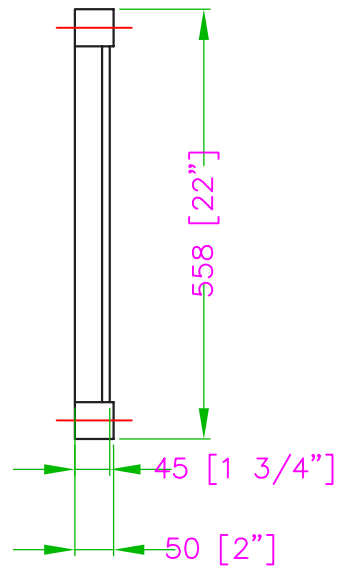
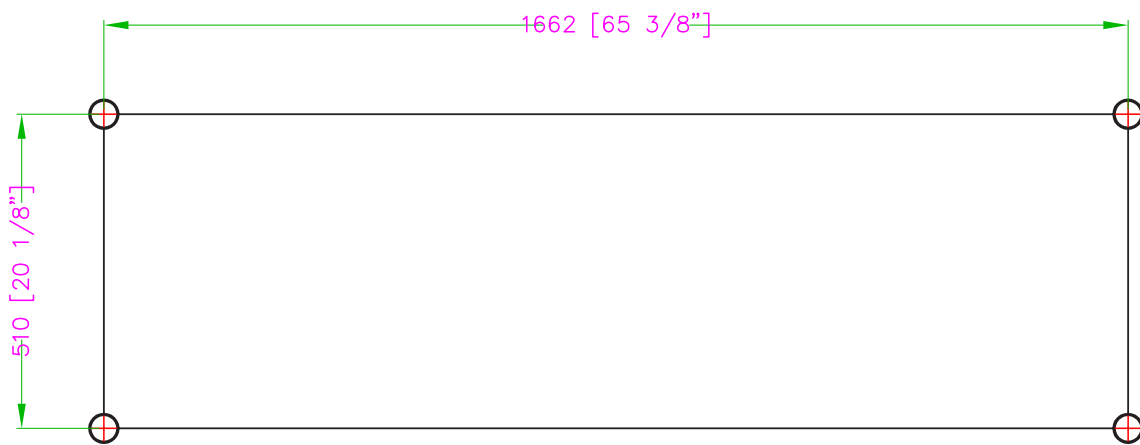

Distributed by:



www.distex.ca

Your Premium Partner