

WORK TABLE

DSST-2436-BK



FEATURES

- ✓ Made with high quality 430 stainless steel
- ✓ Dimensions: 36" x 24" x 34"
- ✓ Easy to assemble
- ✓ Gauge 18
- ✓ Economic shipping weight
- ✓ 5" backsplash



OPTIONAL ACCESSORIES

- ✓ Extra stainless steel undershelf
- ✓ Adjustable stainless steel leg insert
- ✓ Set of swivel casters
- ✓ Brace bar kit

Distributed by:

DISTEX

THORINOX

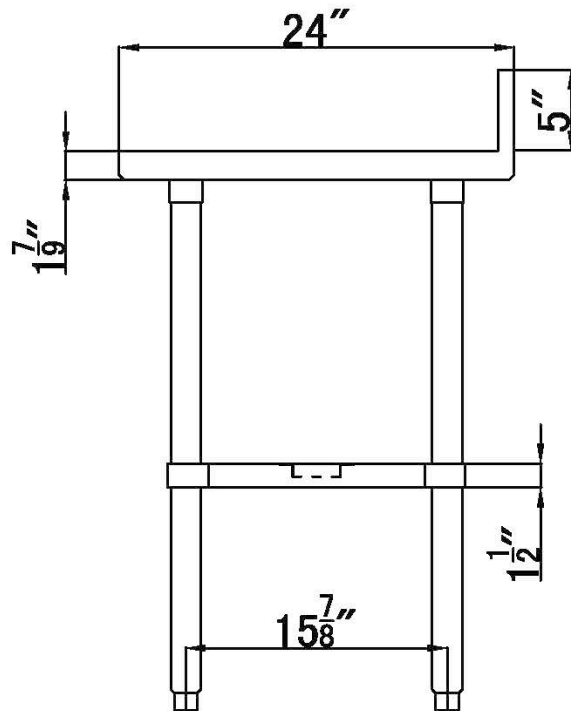
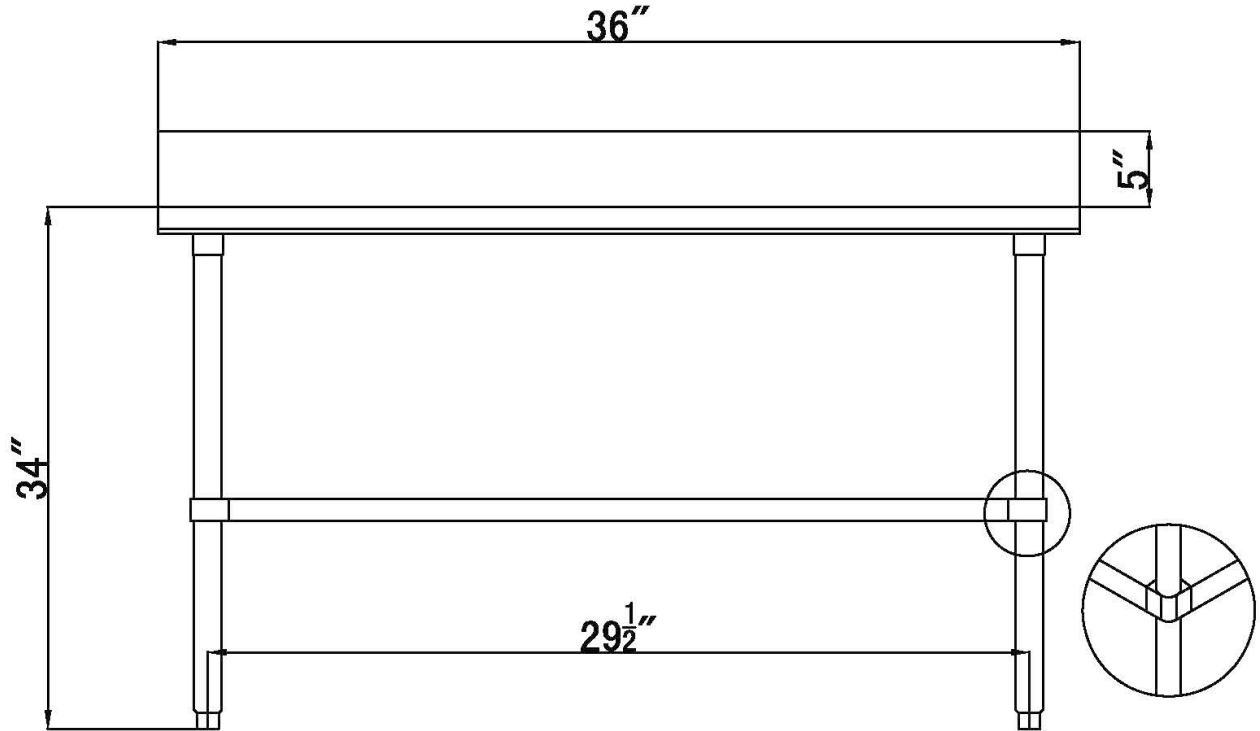

NSF